

X4300

Bridge Navigational Watch Alarm System

BNWAS

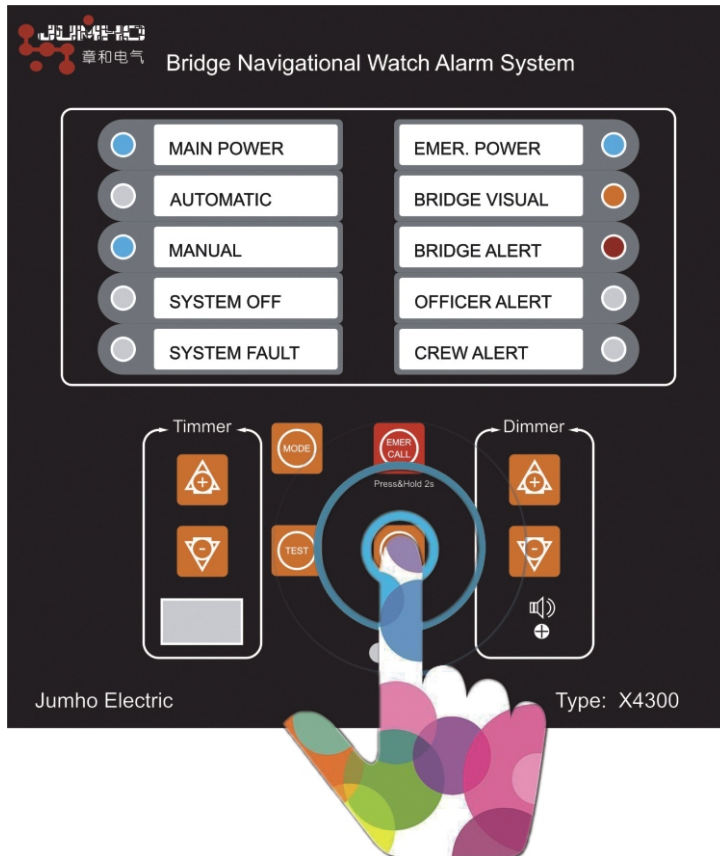

www.jumho.cn

Jumho Electric



International Market (Distributor)
Enersom International Ltd.
Shanghai Enersom Industry Co. Ltd



X4300
Monitor and Display
Unit
X4300M X4300S

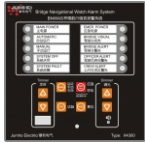

RAP
Bridge Alert
Reset Unit



WAP
Alert Unit

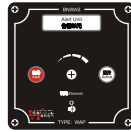

WAP
Alert Unit

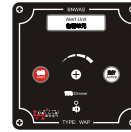

MOT
Motion Reset Unit
(Optional)



X4300

Bridge Navigational Watch Alarm System

The purpose of a bridge navigational watch alarm system (BNWAS) is to monitor bridge activity and detect operator disability which could lead to marine accidents. A watch officer is required to press the button on a Timer Reset Panel or to operate navigation equipment (e.g. ECDIS, Radar, etc.) at certain intervals, which can be set between 3 and 12 minutes. This purpose is achieved by a series of indications and alarms to alert first the officer and, if he is not responding, then to alert the Master or another qualified officer.

Additionally, the BNWAS provides the officer with a means of calling for immediate assistance. The BNWAS should be operational whenever the ship is underway at sea.

- Dormant period: 3-12 min
- Mode selection (OFF, Manual ON, AUTO)
- Set-up menu is protected by password
- Audio and Visual alarm indications
- 1st, 2nd, 3rd alarm indications
- Emergency call
- Reset function
- Dimmer function
- System fail alarm
- Motion reset function
- Backlight automatically lighted when dark
- Radar and Autopilot signal input
- VDR output

Standard

- IMO** MSC.128(75) BNWAS performance standards
- IEC** 62616 Bridge navigational watch alarm system (BNWAS)
- Maritime navigation and radiocommunication equipment and systems

IMO Rules

Implementation schedule of Bridge Navigational Watch Alarm System (BNWAS)

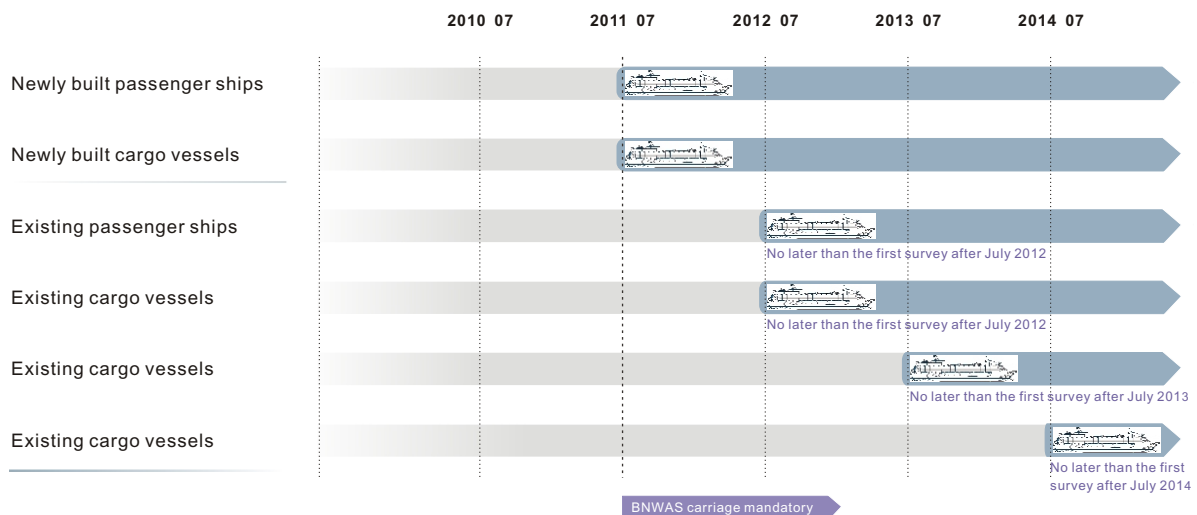

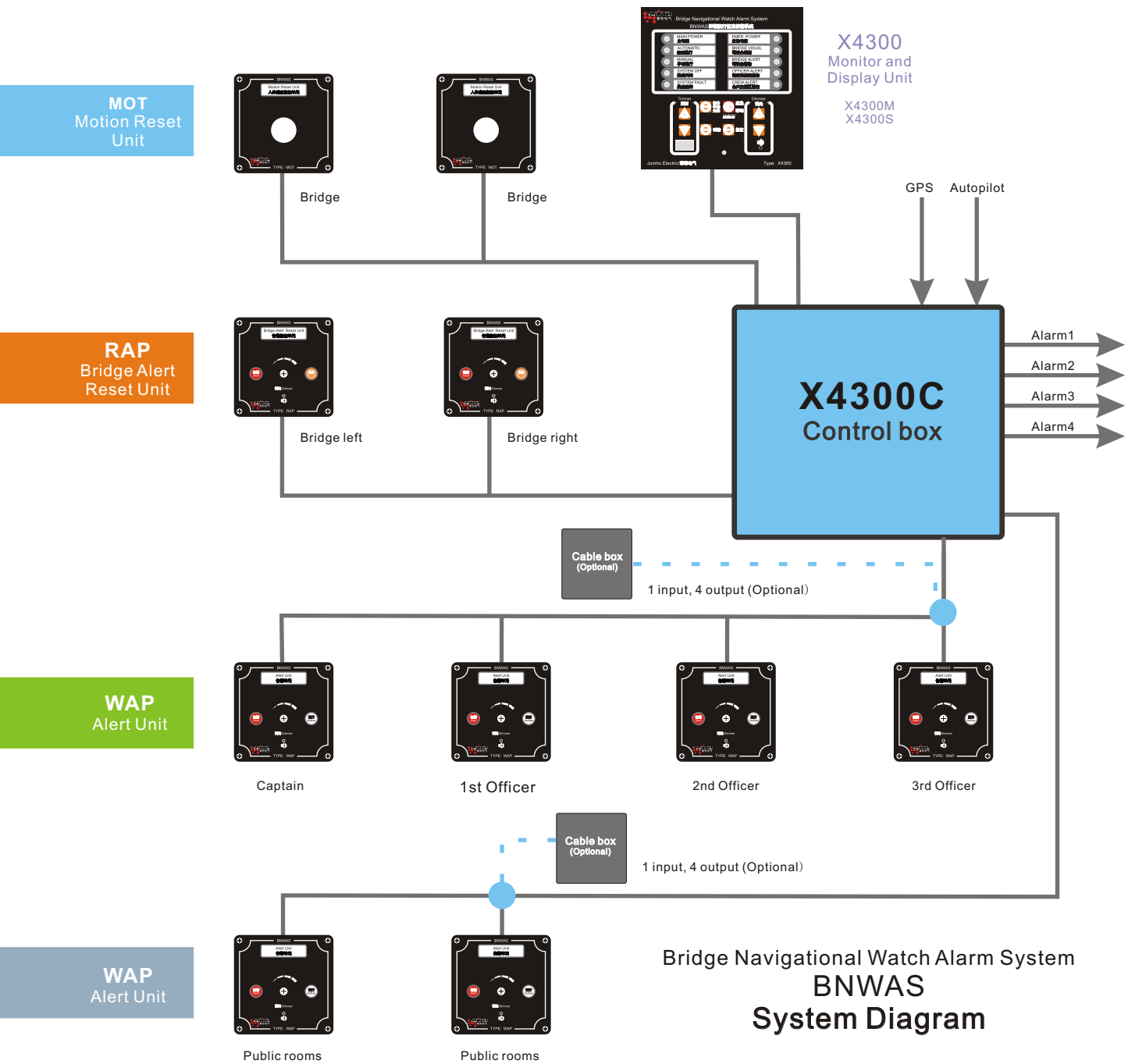

Specifications

Type	Name	Dimensions	Installation	Weight	Protection grade
X4300M	Monitor and Display Unit	144mm (L) X144mm (W) X35mm (D)	Flush	1kg	IP20
X4300S	Display Unit	144mm (L) X144mm (W) X35mm (D)	Flush	1kg	IP20
X4300C	Control box	410mm (L) X356mm (W) X190mm (D)	Wall-mounted	5kg	IP44
RAP	Bridge Alert Reset Unit	94mm (L) X94mm (W) X55mm (D)	Flush/Wall-mounted	300g	IP54
WAP	Alert Unit (2nd stage)	94mm (L) X94mm (W) X55mm (D)	Flush/Wall-mounted	300g	IP21
WAP	Alert Unit (3rd stage)	94mm (L) X94mm (W) X55mm (D)	Flush/Wall-mounted	300g	IP21
MOT	Motion Reset Unit	94mm (L) X94mm (W) X55mm (D)	Flush/Wall-mounted	300g	IP21

X4300 System Selection

Bridge Navigational Watch Alarm System

Name	Type	Economy	Standard
Monitor and Display Unit	X4300M		1
Display Unit	X4300S	1	
Control Box	X4300C	1	1
Bridge Alert Reset Unit	RAP	2	2
Alert Unit (2nd stage)	WAP	4	4
Alert Unit (3rd stage)	WAP	2	2
Motion Reset Unit	MOT		2*

Notes: * means optional options.

Alarm sequence

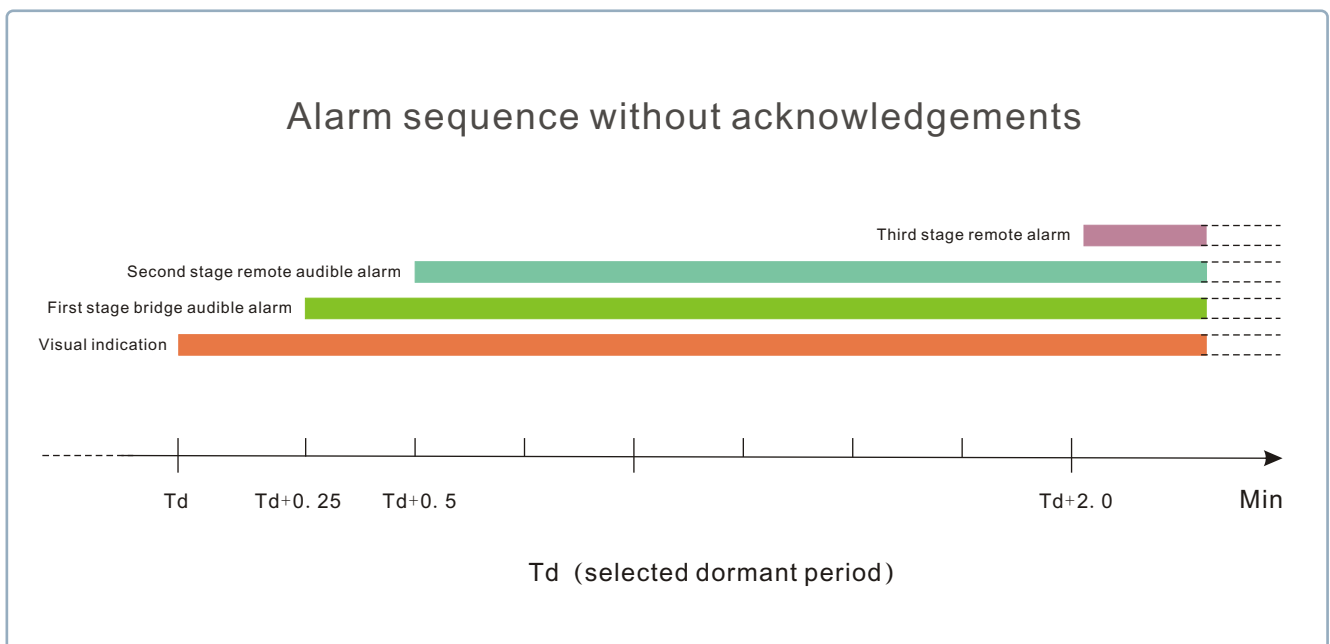

Competence in Marine Automation

X4300 bridge navigational watch alarm system sequence

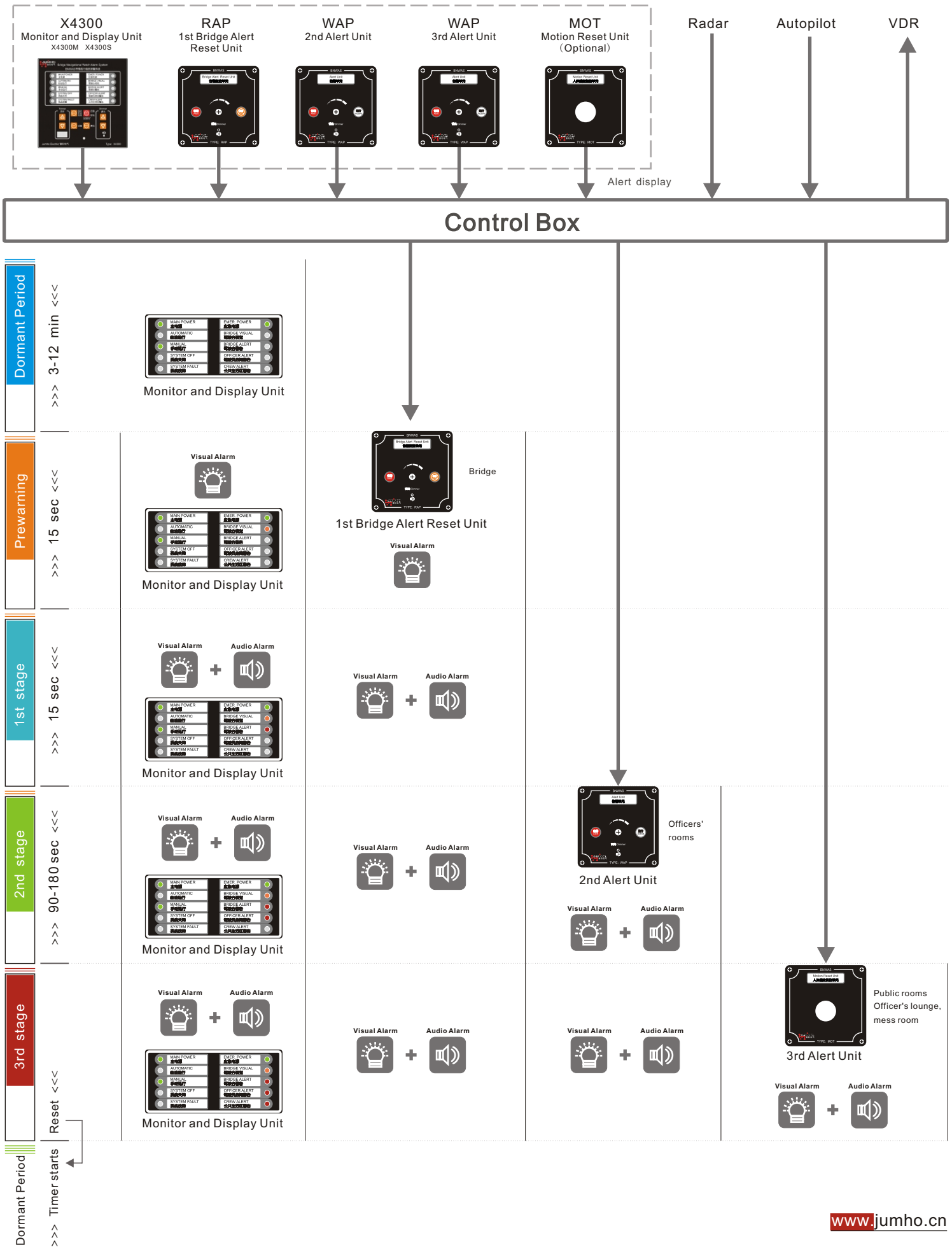

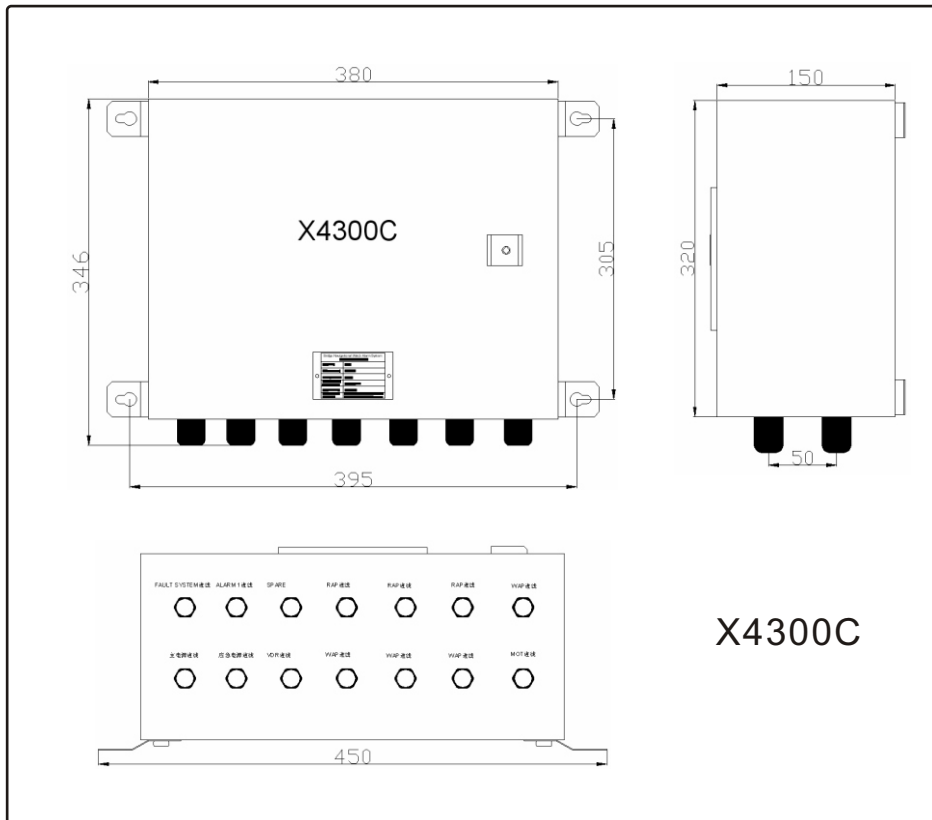

X4300

Bridge Navigational Watch Alarm System

Dimension drawing

Unit: millimeter

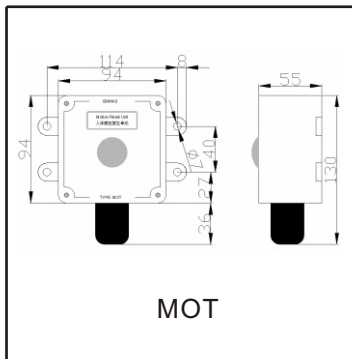
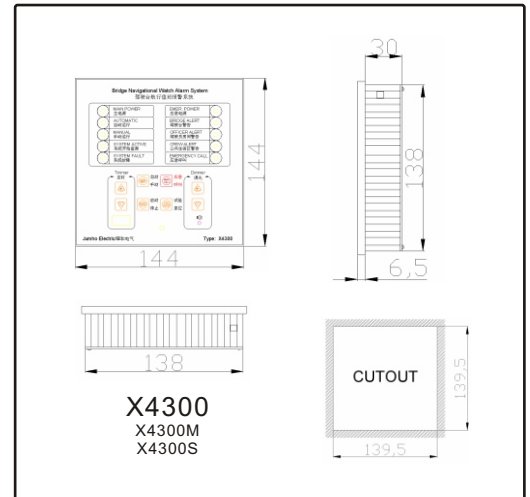

MOT

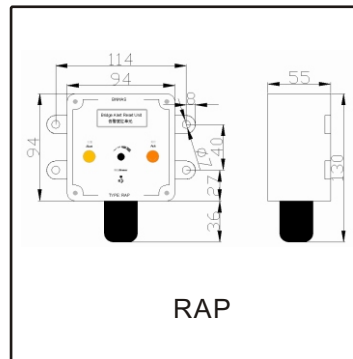

RAP

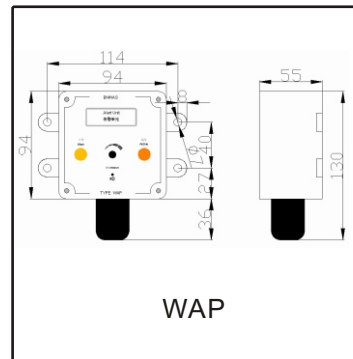

WAP

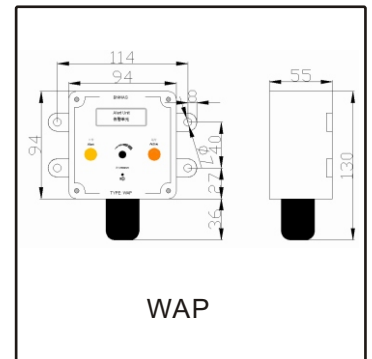

WAP

International Market (Distributor):

Enersom International Ltd.

Shanghai Enersom Industry Co. Ltd.

Tel: +86 (20) 8234 6488

Fax: +86 (20) 8234 6488

Fax: +86-21-5102 6611

Contact: Danny Chang

Mobile: +86-139 1662 1898

E-mail: dannychang@enersom.com

www.enersom.com

www.jumho.cn

Jumho Electric

Headquarters

Jumho Electric (Guangzhou) CO., LTD

Jumho Electric (Guangzhou)

Tel: +86 (20) 8234 6488 E-mail: jumho@jumho.cn

Fax: +86 (20) 8234 6488 www.jumho.cn

No.15 Dagan Middle Road, Huangcun, Tianhe, Guangzhou, China(510663)

Singapore Marine Support Center

Seaplus Controls Pte Ltd

Tel: +65 6264 2963

Fax: +65 6264 2564

10, Tractor Road, # M3-c5, Singapore 627971

E-mail: seaplus@singnet.com.sg

www.seaplus-controls.com

India and Pakistan Marine Support Center

Cetus Automation Pte Ltd

Tel: +65 66380589

www.cetusautomation.com

No:45, Kian Tech Drive, #01-1J, Singapore -628 859

E-mail: admin@cetusautomation.com

JUMHO ELECTRIC(HK)CO.,LTD

Jumho Electric (HONGKONG)

Tel: (852) 2545 7777

Fax: (852) 2854 2875

Rm 601-2 Chuk On Building, 23 Mercer Street, Sheung Wan, HONGKONG, 49-51.7B2-0308

Europe Support Center

(Including Italy, France, Spain and Mediterranean countries)

TechnoLeader s.r.l.

Tel: +39-0108688076

Fax: +39-0108688913

C.so Torino 30/18, 16129 - Genova - ITALY

Middle East Support Center

ZENER ELECTRONICS SERVICES

Tel: 00971-4-3522880

Fax: 00971-4-3524410

P.O. BOX NO:389, AL SHARAFI BUILDING, KHALID BIN WALEED STREET, BUR DUBAI, DUBAI, U.A.E